

CSMIO/IP-M

4.3 Digital inputs connector

PIN number	Description
1	0 (+) Input
2	1 (+) Input
3	2 (+) Input
4	3 (+) Input
14	0 (-) Input
15	1 (-) Input
16	2 (-) Input
17	3 (-) Input

PIN number	Description
9	24V power supply for 0.3 outputs
10	Output 0
22	0V power supply for 0.3 outputs

PIN number	Description
14	DIR[0]-
15	DIR[0]+
16	STEP[0]-
17	STEP[0]+

PIN number	Description
16	DIR[1]-
17	DIR[1]+
18	STEP[1]-
19	STEP[1]+

PIN number	Description
18	DIR[2]-
19	DIR[2]+
20	STEP[2]-
21	STEP[2]+

Pin number	Description
1	Power -24V DC
2	GND
3	ground

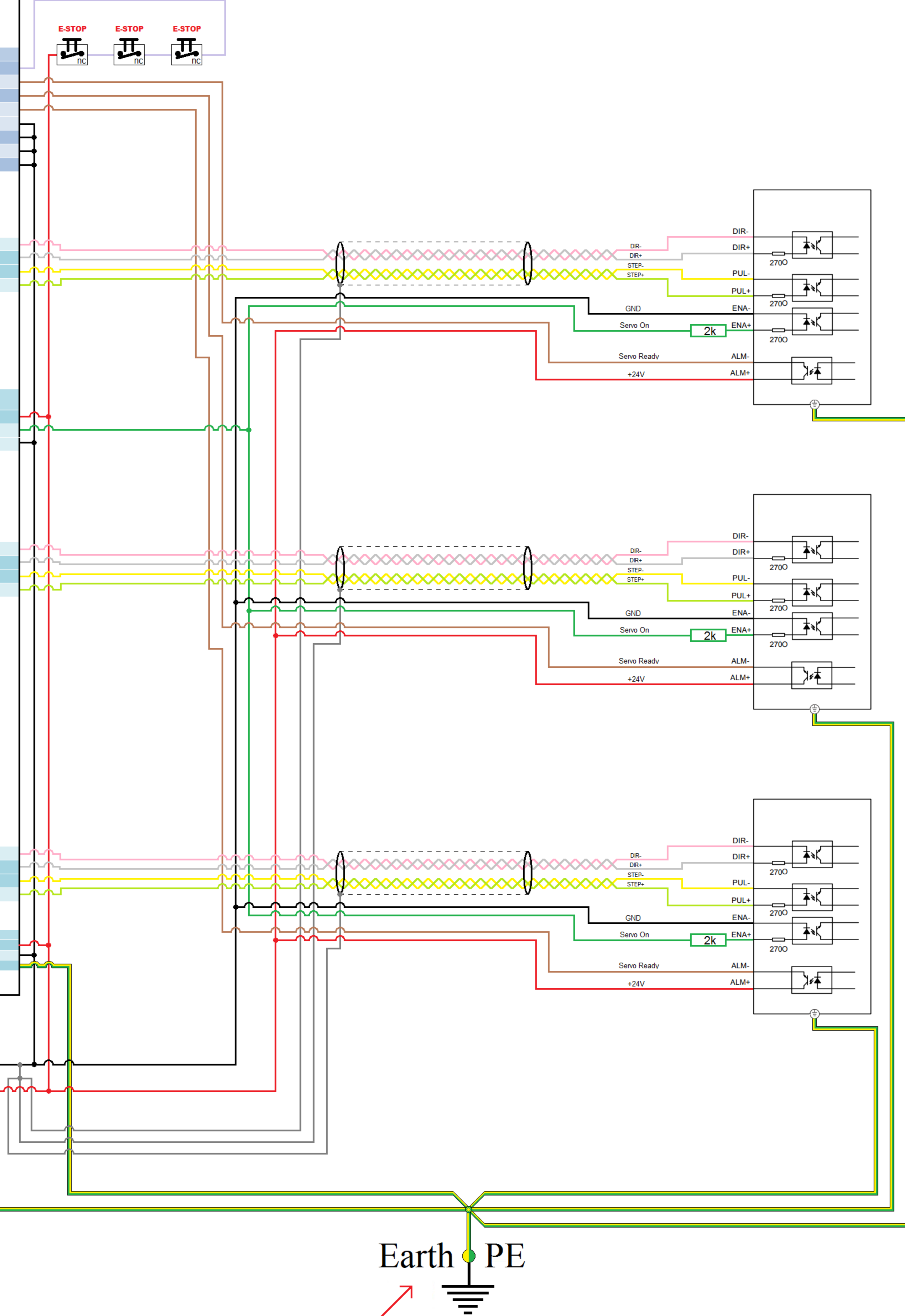

Earth Bars
Listwa uziemiająca

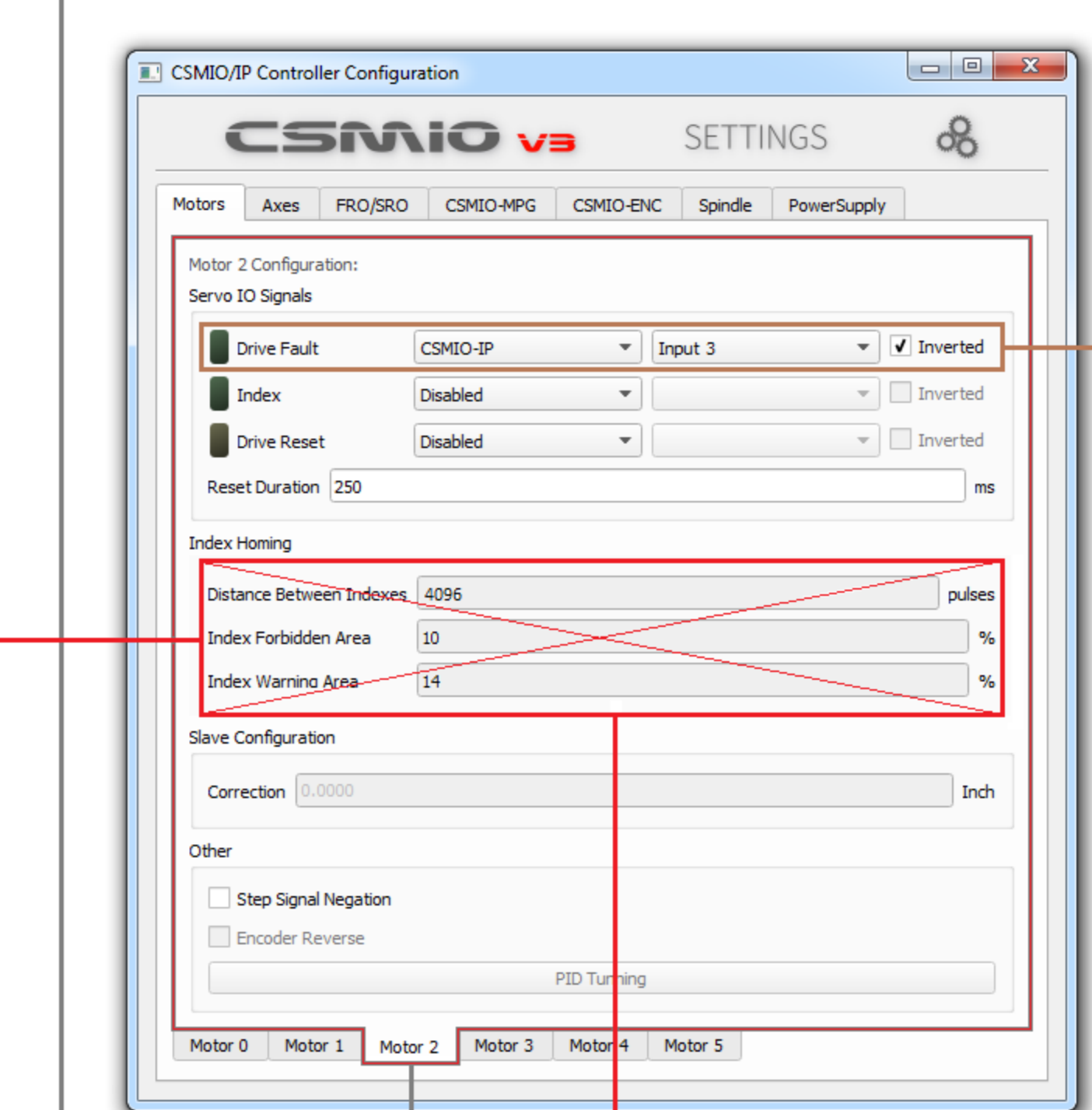
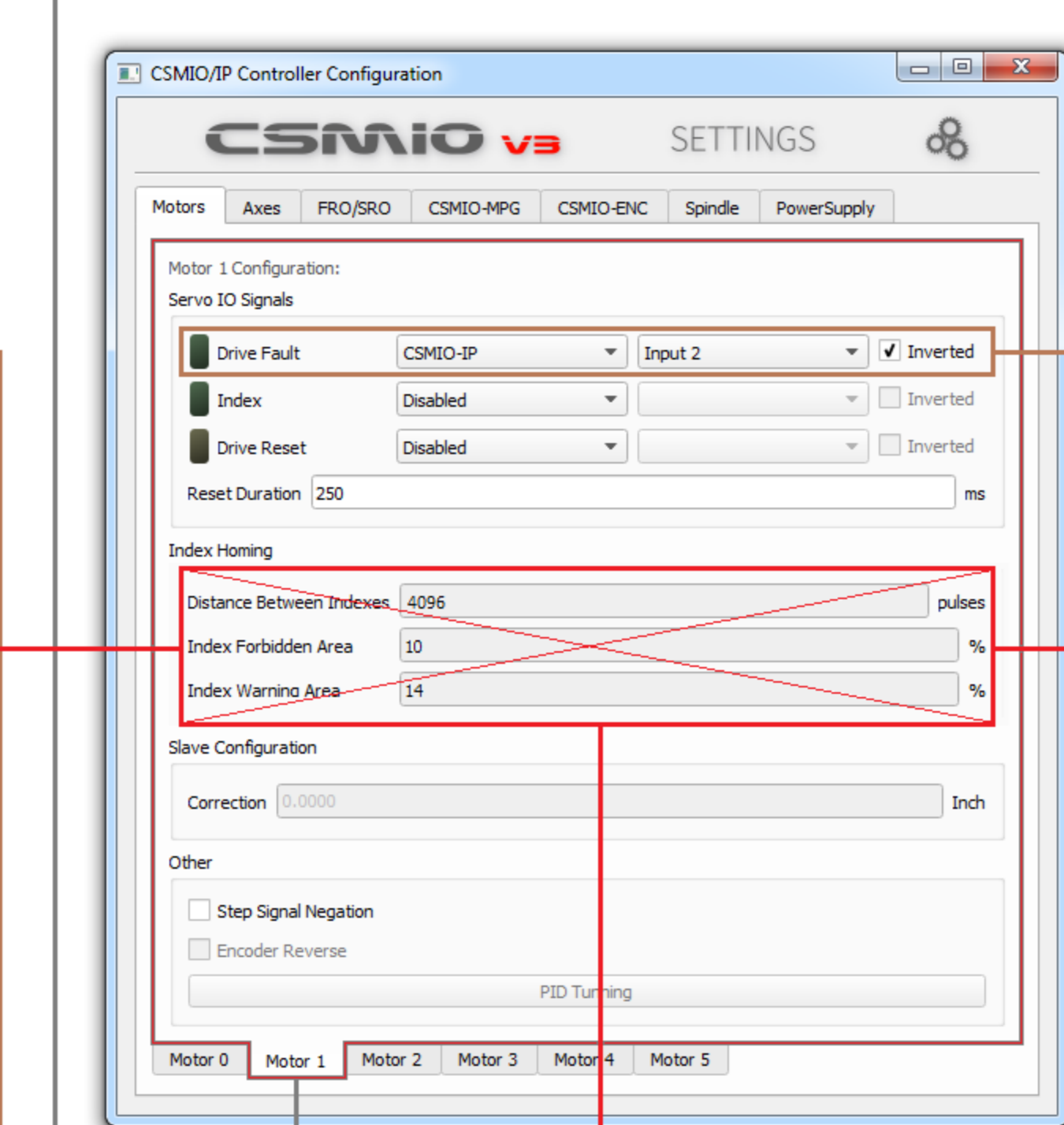
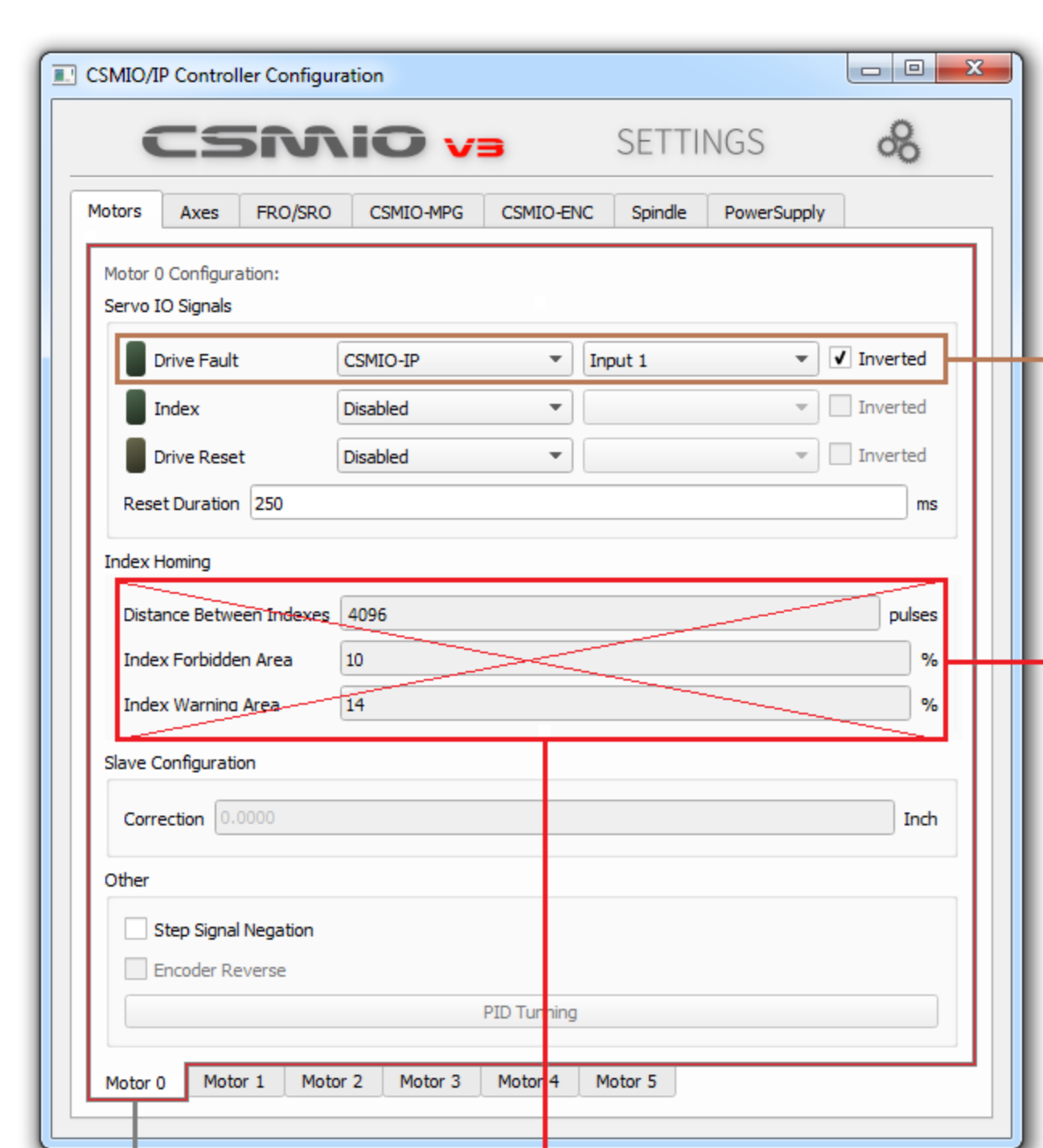
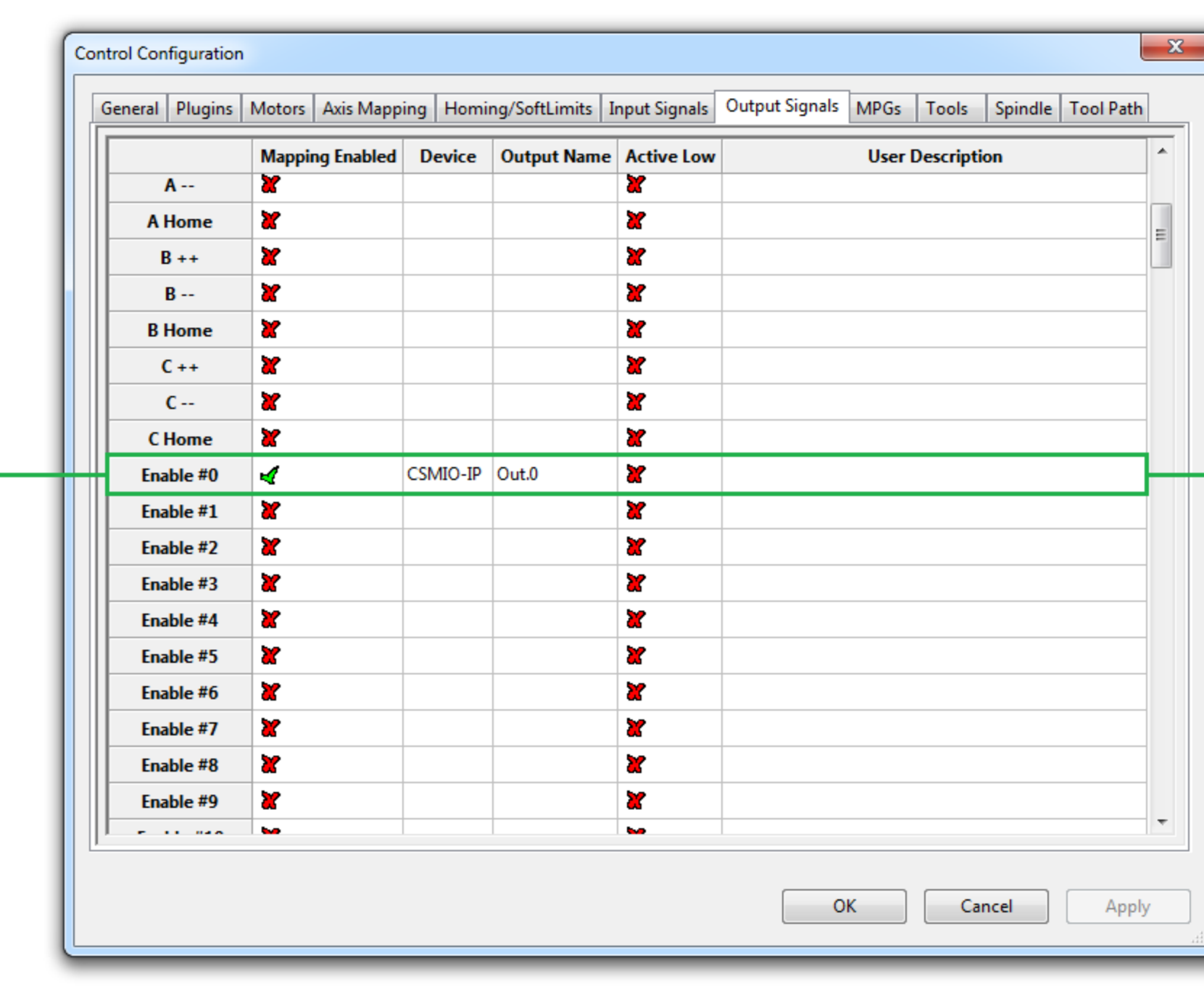
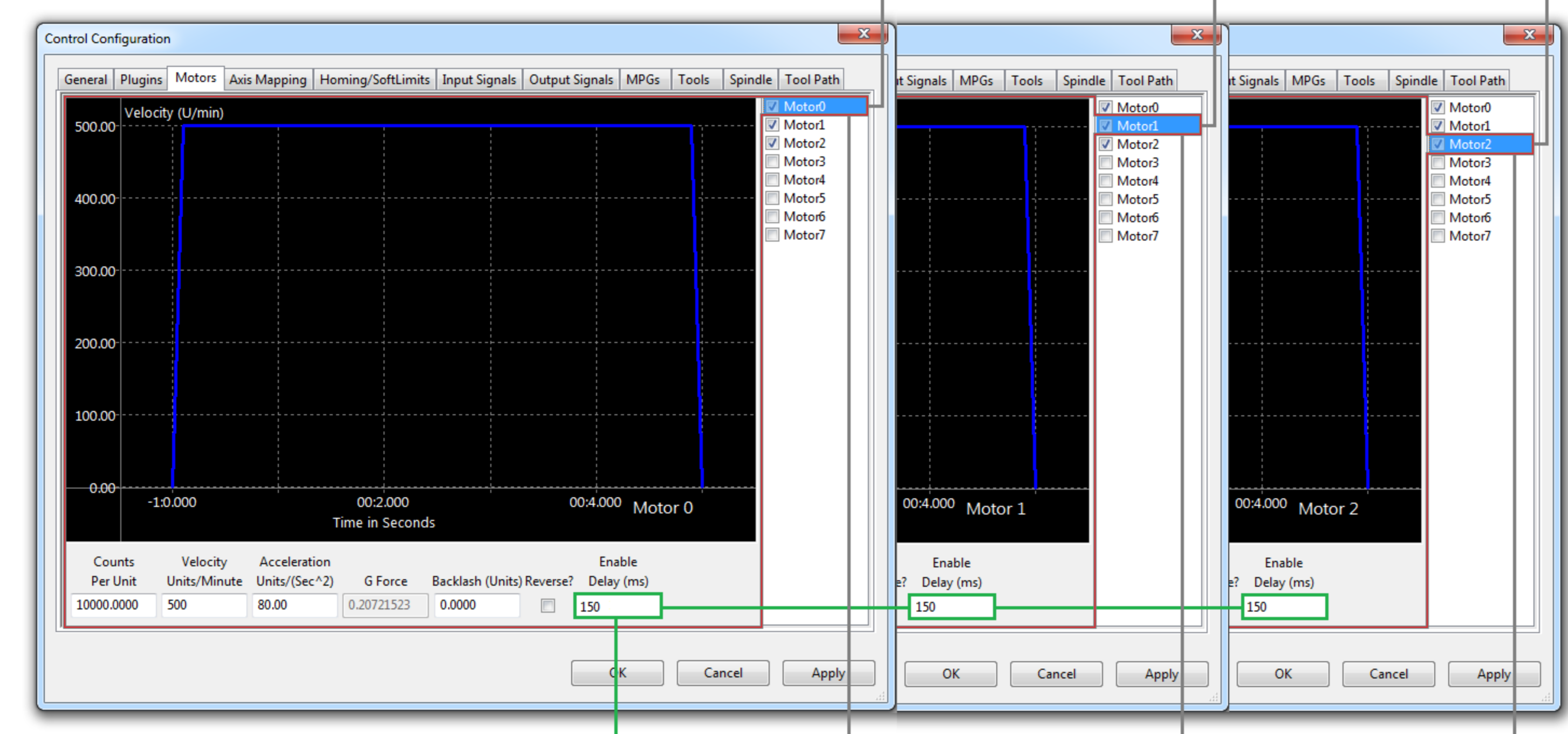
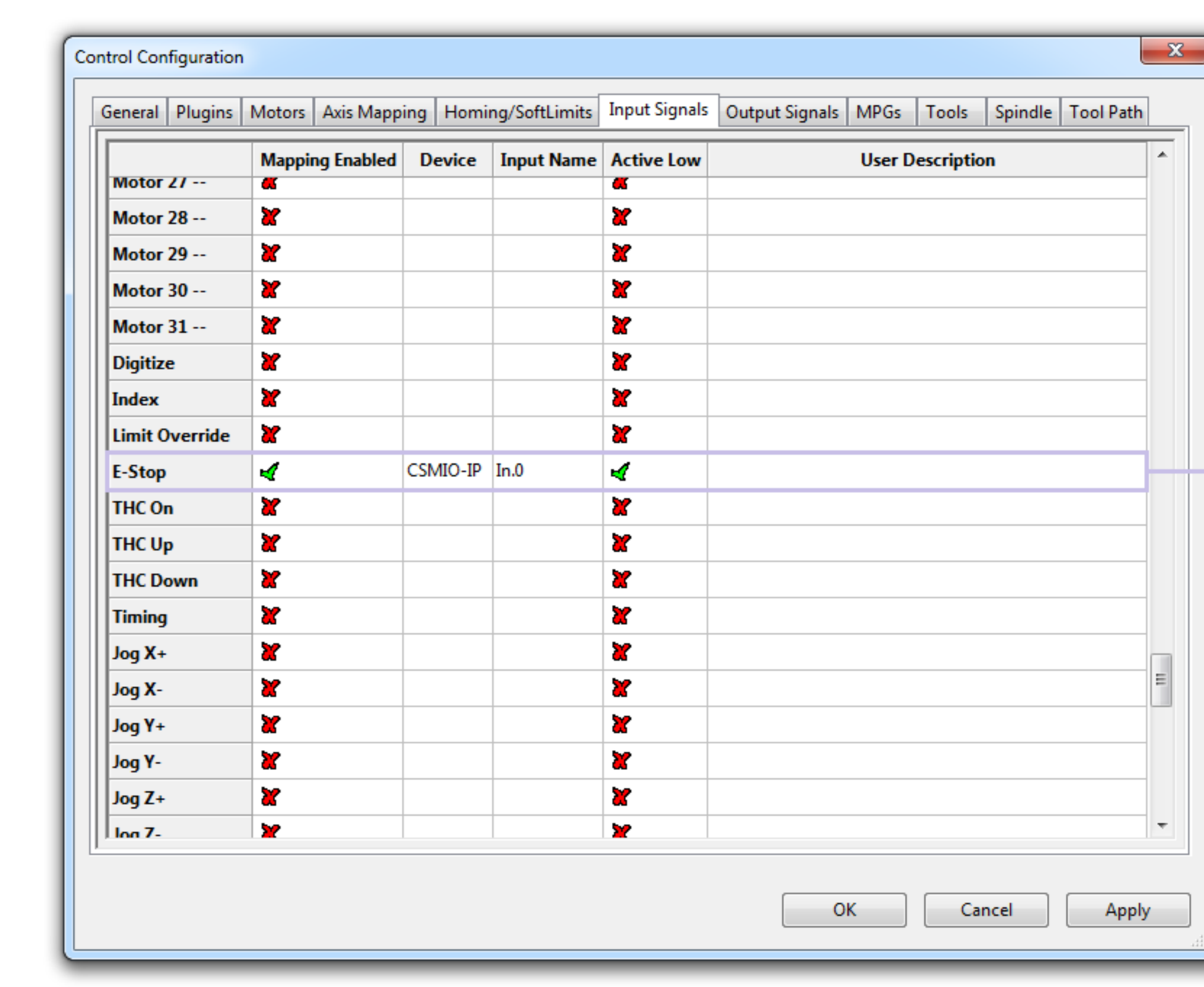
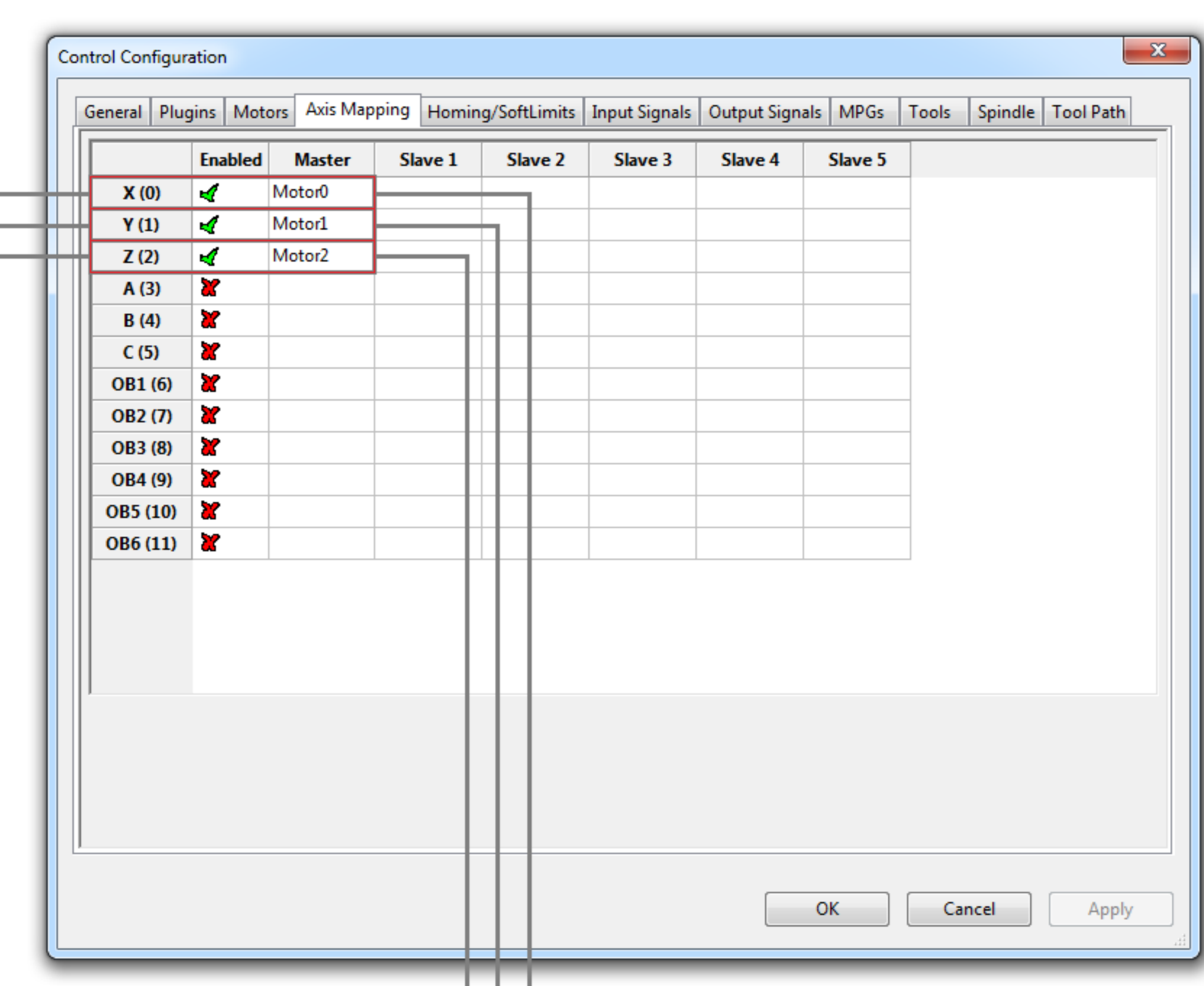
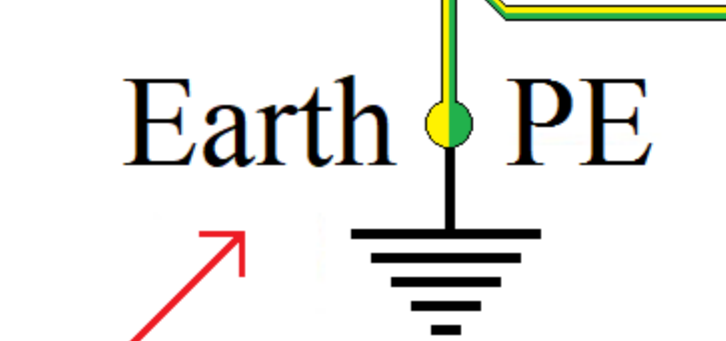

CSMIO / IP-M controller does not support the index signal

