

CSMIO / IP-M controller does not support the index signal

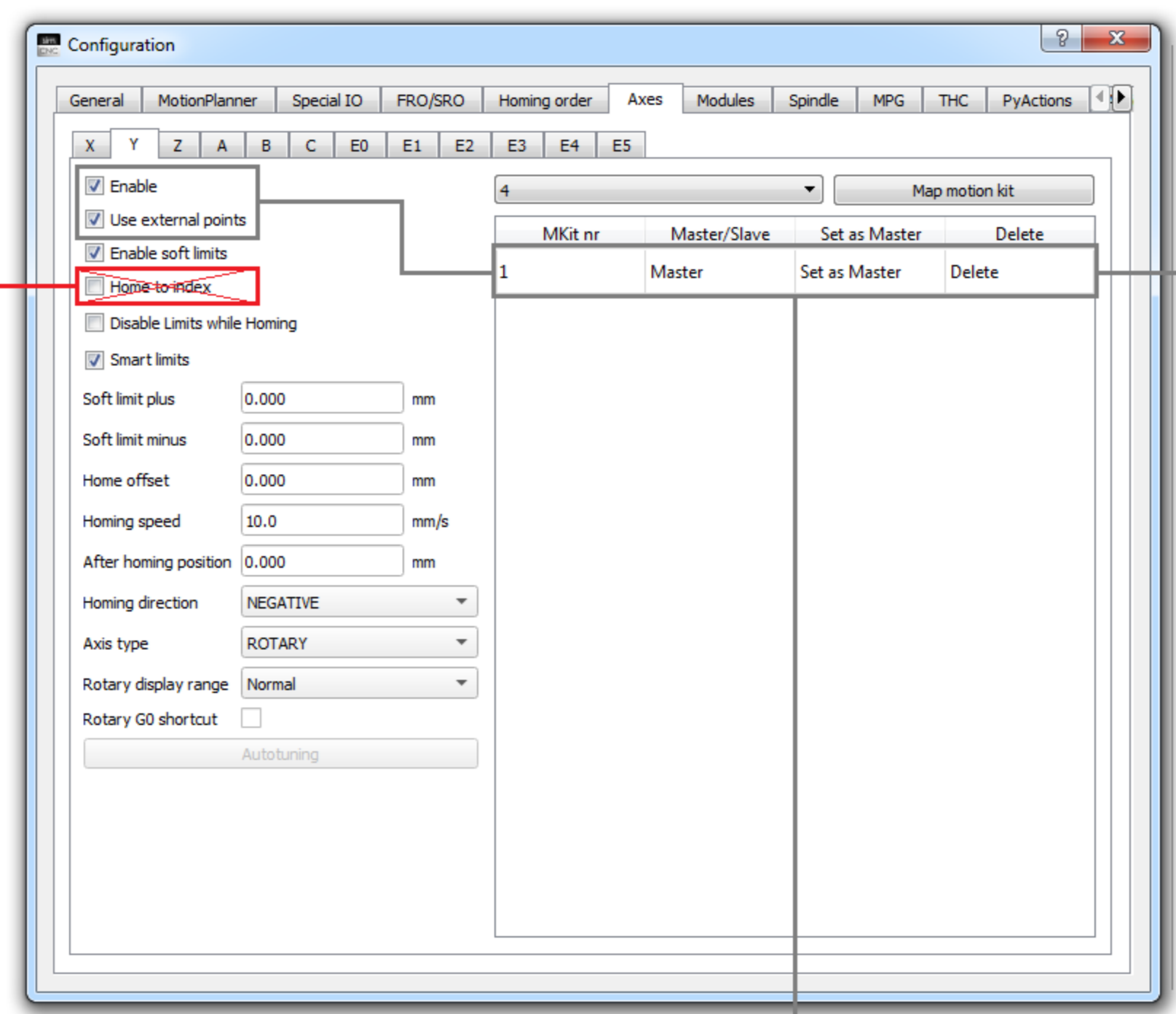

CSMIO / IP-M controller does not support the index signal

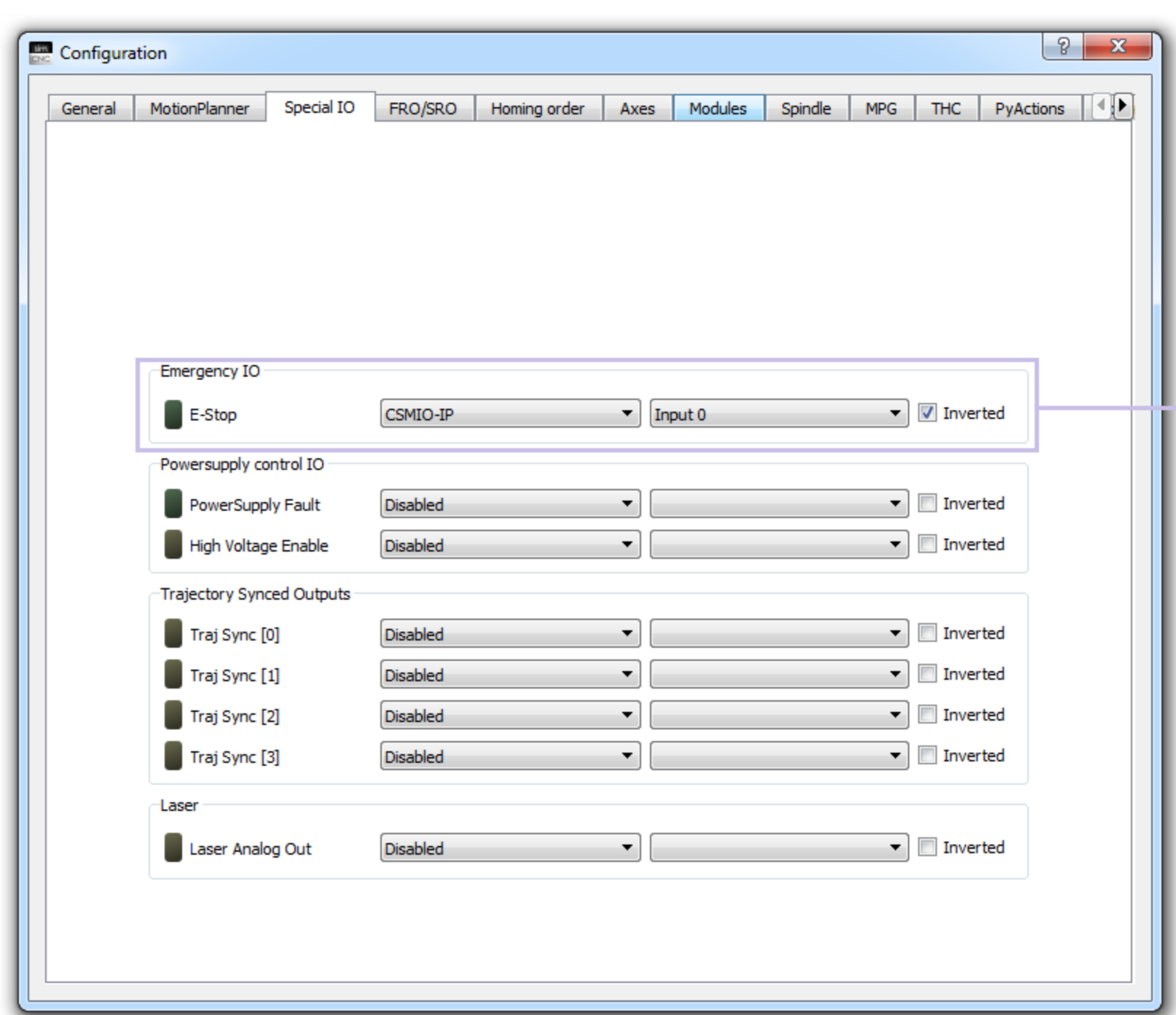
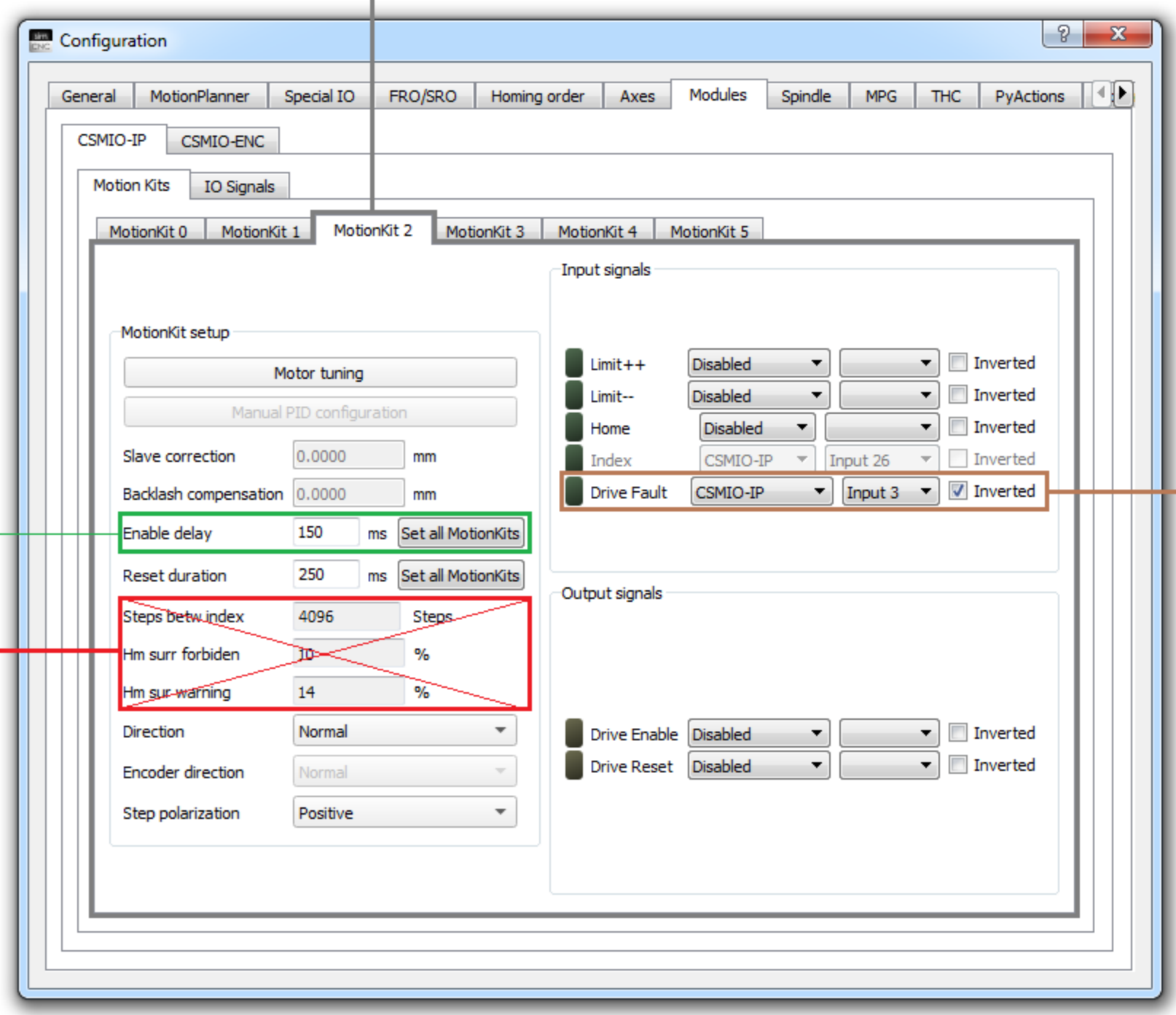
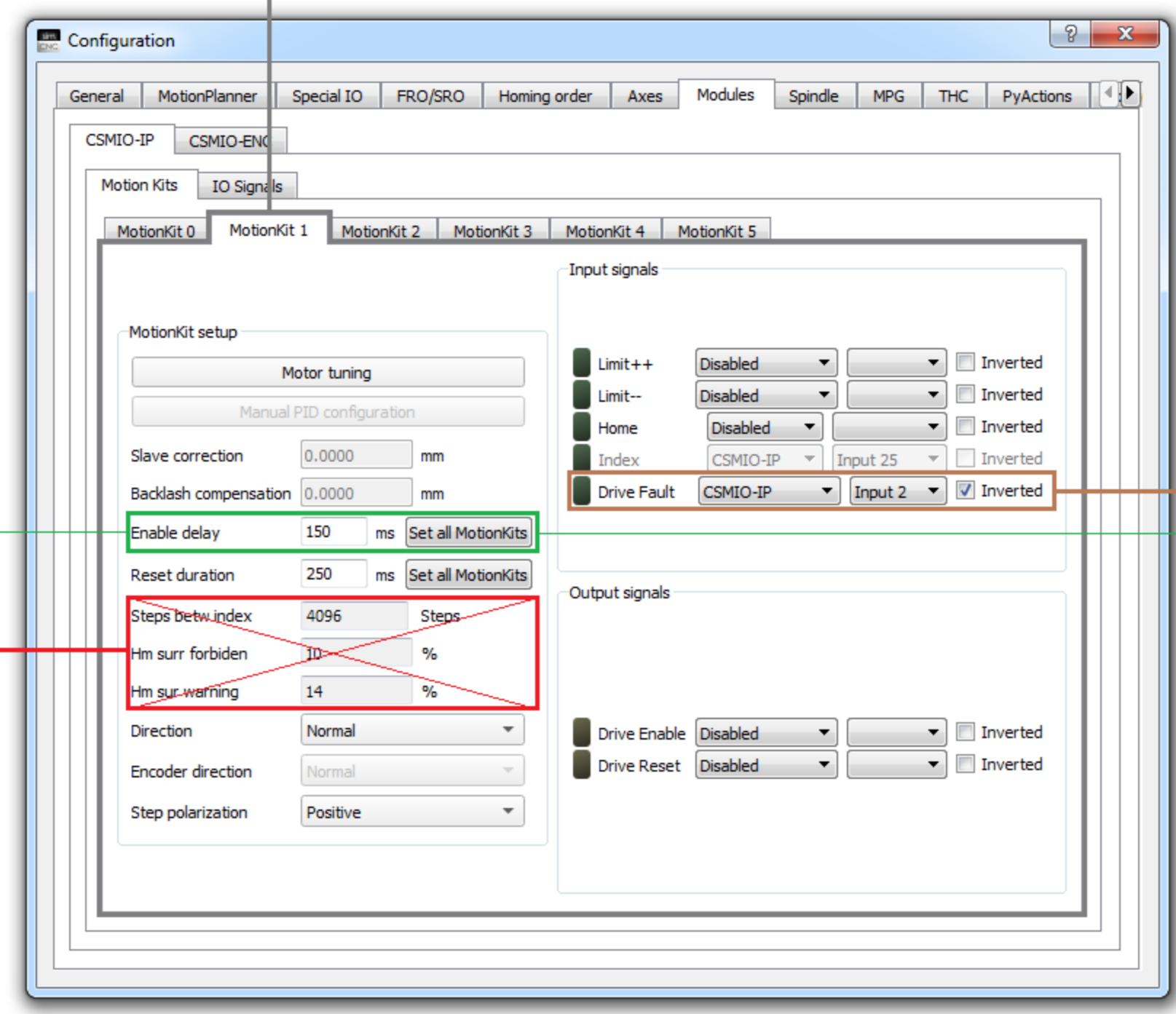
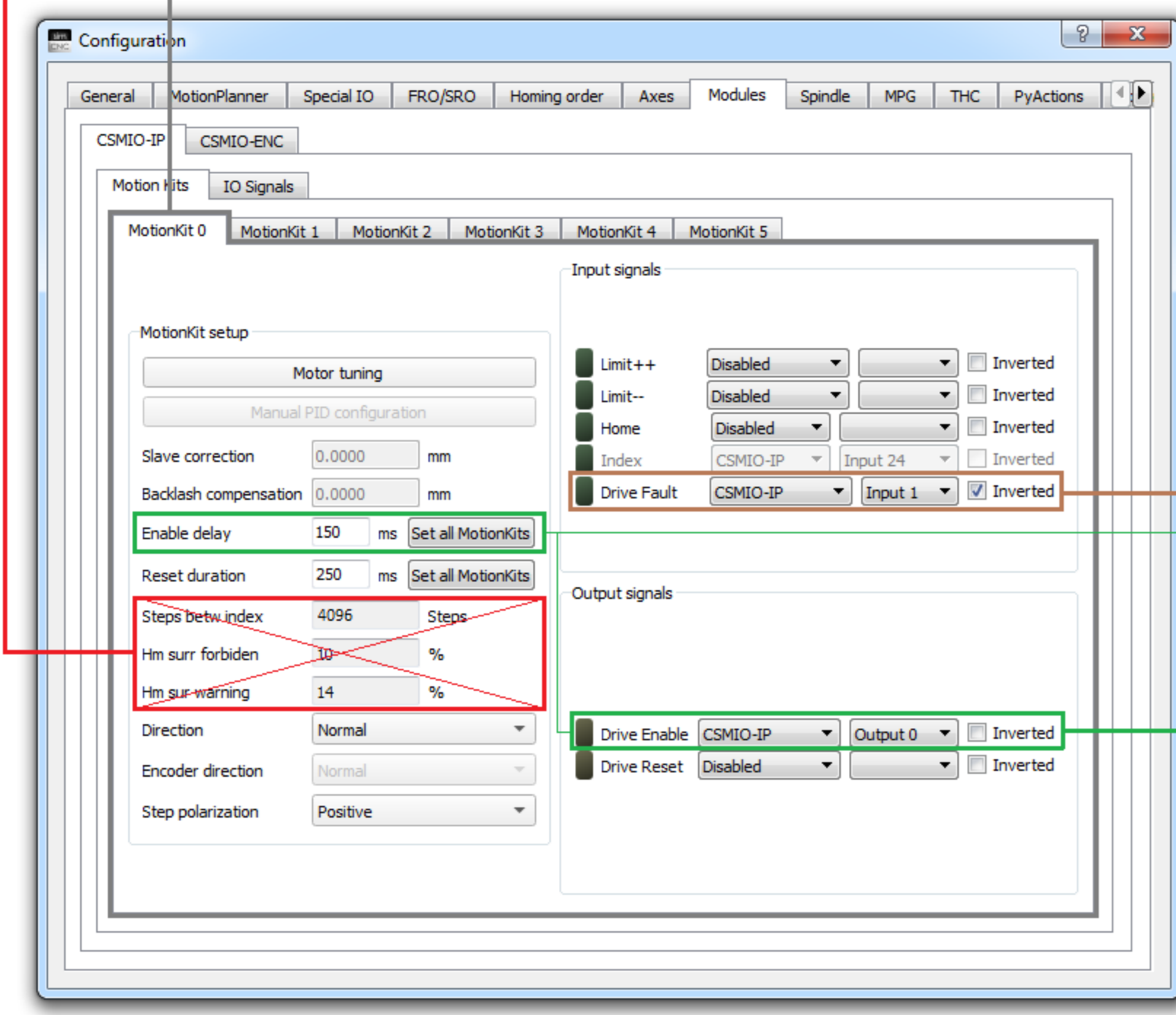
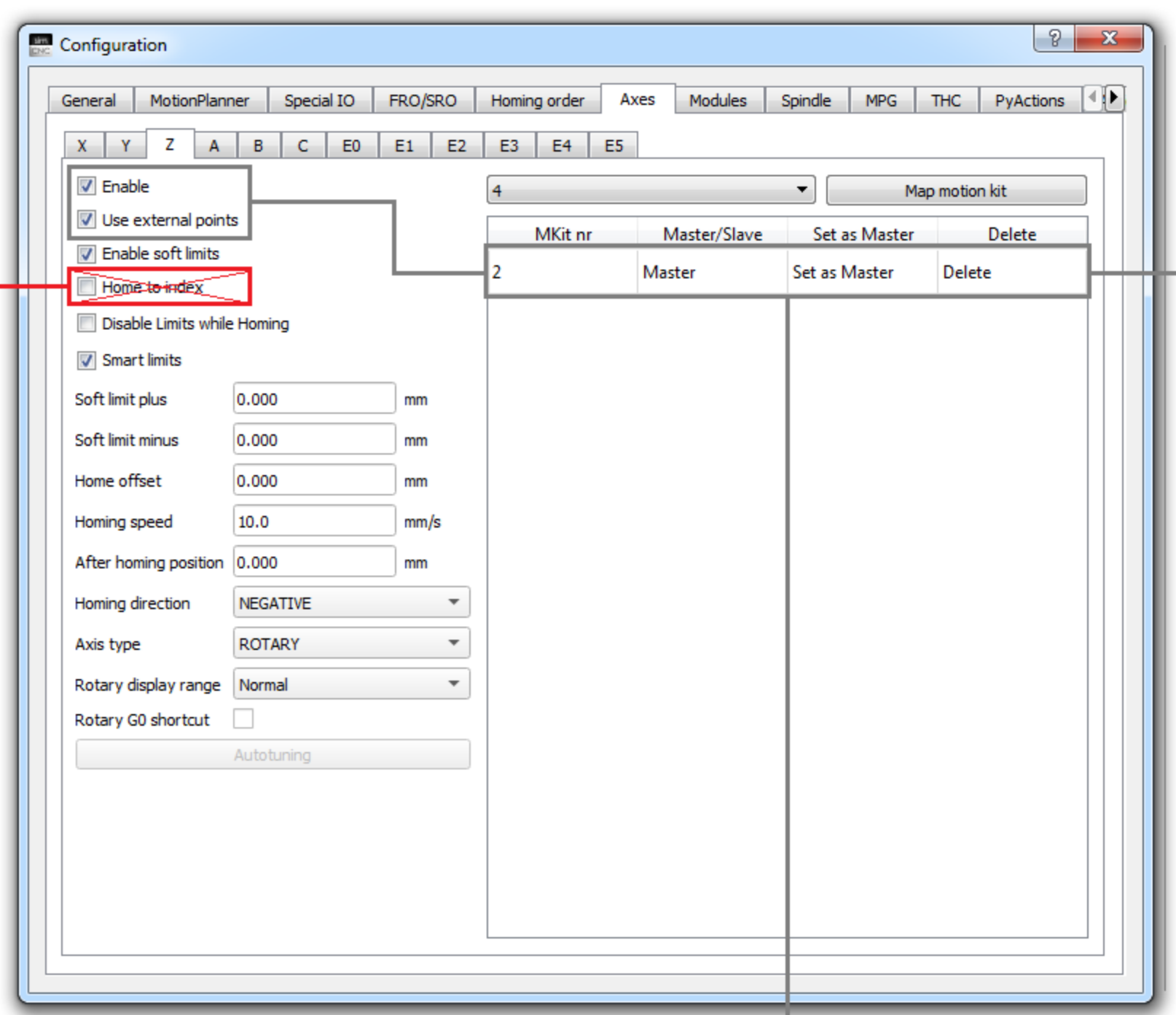

CSMIO/IP-M

4.3 Digital inputs connector

PIN number	Description
1	0 (+) Input
2	1 (+) Input
3	2 (+) Input
4	3 (+) Input
14	0 (-) Input
15	1 (-) Input
16	2 (-) Input
17	3 (-) Input

PIN number	Description
14	DIR[0]-
15	DIR[0]+
2	STEP[0]+

PIN number	Description
9	24V power supply for 0.3 outputs
10	Output 0
22	0V power supply for 0.3 outputs

PIN number	Description
16	DIR[1]-
3	DIR[1]+
17	STEP[1]-
4	STEP[1]+

PIN number	Description
18	DIR[2]-
5	DIR[2]+
19	STEP[2]-
6	STEP[2]+

PIN number	Description
1	Power = 24V DC
2	GND
3	ground

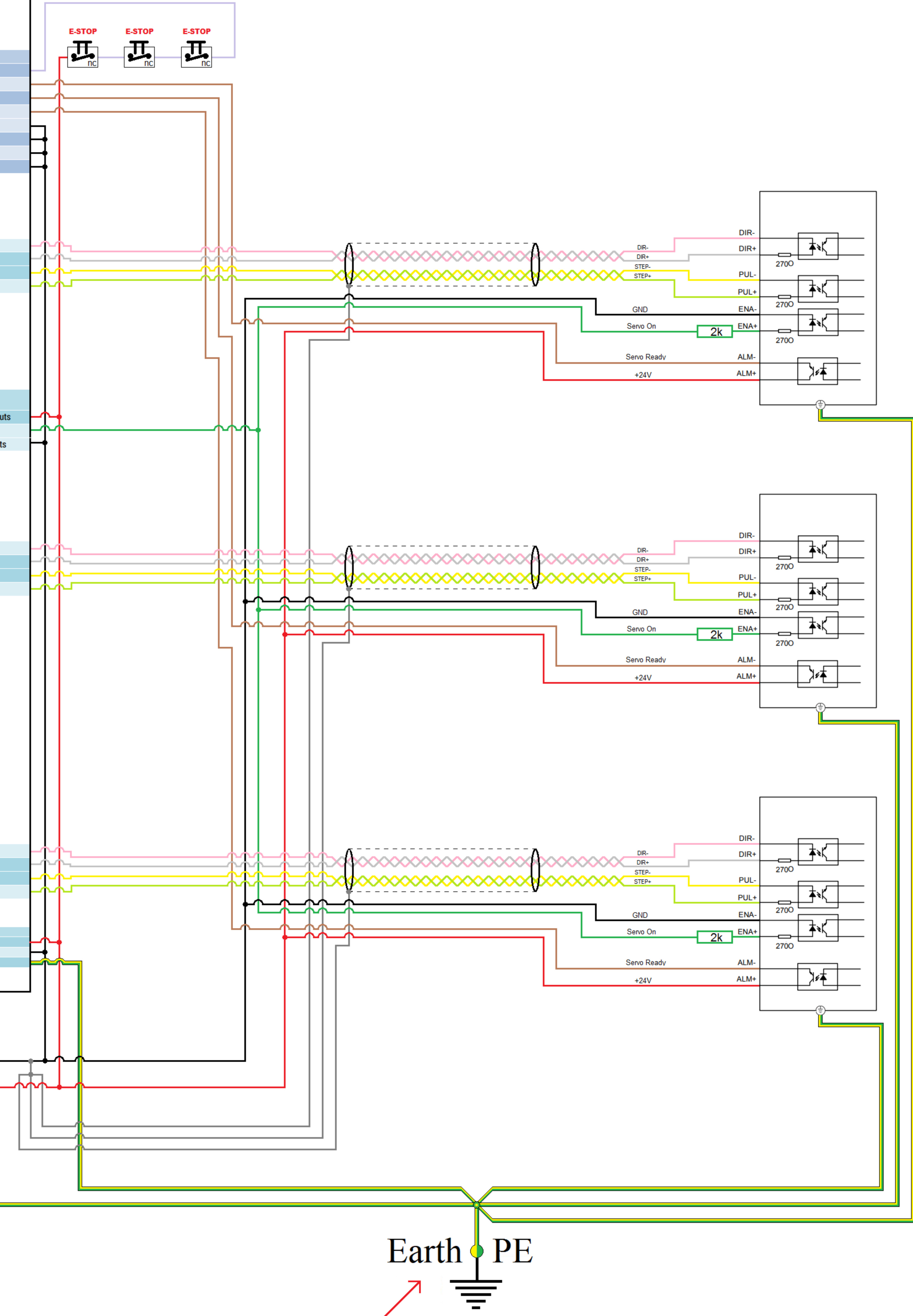
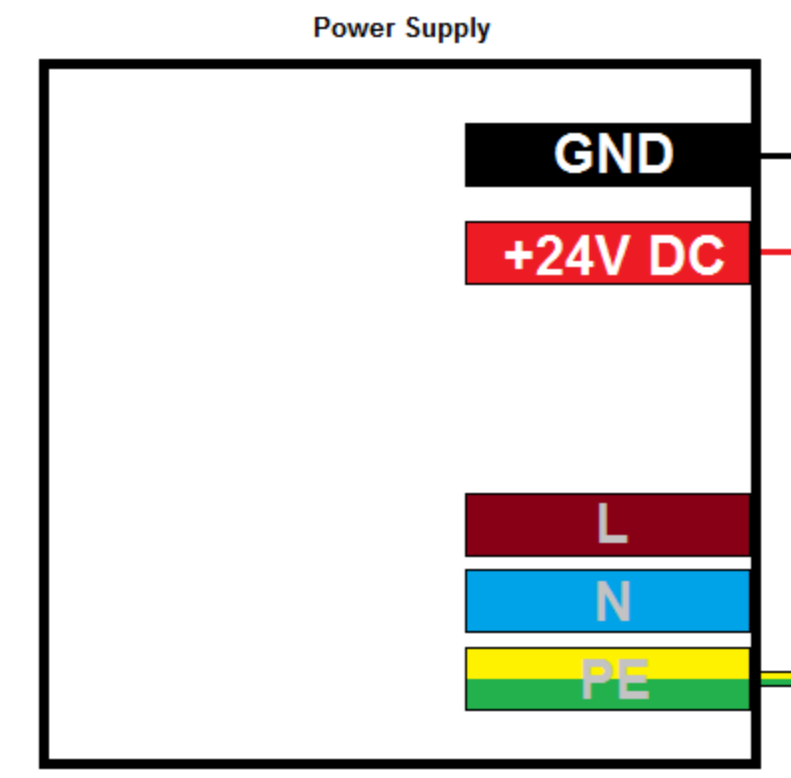

Earth Bars
Listwa uziemiająca

